

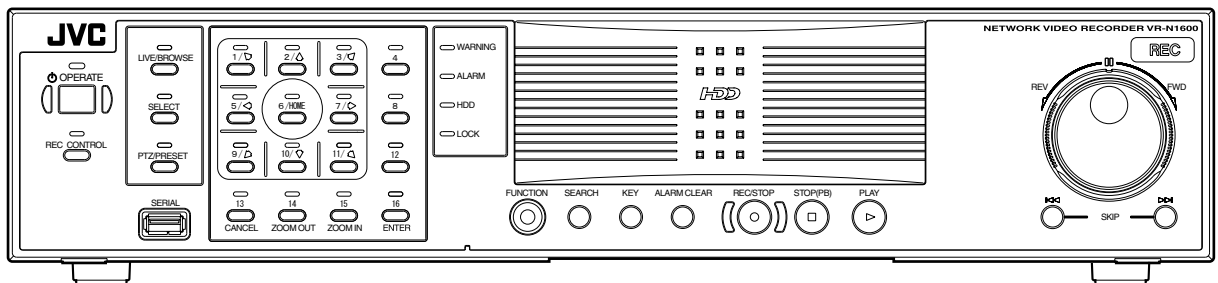

NETWORK VIDEO RECORDER

VR-N1600U VR-N1600E

STARTUP GUIDE (A)



Powered by Milestone

Please read the following before getting started:

Thank you for purchasing this JVC product.
Before operating this unit, please read the instructions carefully to ensure the best possible performance.

For Customer Use:

Enter below the Serial No. which is located on the body.
Retain this information for future reference.

Model No. VR-N1600U

Serial No. _____

IMPORTANT SAFEGUARDS

1. Read all of these instructions.
2. Save these instructions for later use.
3. All warnings on the product and in the operating instructions should be adhered to.
4. Unplug this appliance system from the wall outlet before cleaning. Do not use liquid cleaners or aerosol cleaners. Use a damp cloth for cleaning.
5. Do not use attachments not recommended by the appliance manufacturer as they may cause hazards.
6. Do not use this appliance near water - for example, near a bathtub, washbowl, kitchen sink, or laundry tub, in a wet basement, or near a swimming pool, etc.
7. Do not place this appliance on an unstable cart, stand, or table. The appliance may fall, causing serious injury to a child or adult, and serious damage to the appliance. Use only with a cart or stand recommended by the manufacturer, or sold with the appliance. Wall or shelf mounting should follow the manufacturer's instructions, and should use a mounting kit approved by the manufacturer. An appliance and cart combination should be moved with care. Quick stops, excessive force, and uneven surfaces may cause the appliance and cart combination to overturn.
8. Slots and openings in the cabinet and the back or bottom are provided for ventilation, and to insure reliable operation of the appliance and to protect it from overheating, these openings must not be blocked or covered. The openings should never be blocked by placing the appliance on a bed, sofa, rug, or other similar surface. This appliance should never be placed near or over a radiator or heat register. This appliance should not be placed in a built-in installation such as a bookcase unless proper ventilation is provided.
9. This appliance should be operated only from the type of power source indicated on the marking label. If you are not sure of the type of power supplied to your home, consult your dealer or local power company. For appliance designed to operate from battery power, refer to the operating instructions.
10. This appliance system is equipped with a 3-wire grounding type plug (a plug having a third (grounding pin). This plug will only fit into a grounding-type power outlet. This is a safety feature. If you are unable to insert the plug into the outlet, contact your electrician to replace your obsolete outlet. Do not defeat the safety purpose of the grounding plug.
11. For added protection for this product during a lightning storm, or when it is left unattended and unused for long periods of time, unplug it from the wall outlet and disconnect the antenna or cable system. This will prevent damage to the product due to lightning and power-line surges.
12. Do not allow anything to rest on the power cord. Do not locate this appliance where the cord will be abused by persons walking on it.
13. Follow all warnings and instructions marked on the appliance.
14. Do not overload wall outlets and extension cords as this can result in fire or electric shock.
15. Never push objects of any kind into this appliance through cabinet slots as they may touch dangerous voltage points or short out parts that could result in a fire or electric shock. Never spill liquid of any kind on the appliance.
16. Do not attempt to service this appliance yourself as opening or removing covers may expose you to dangerous voltage or other hazards. Refer all servicing to qualified service personnel.
17. Unplug this appliance from the wall outlet and refer servicing to qualified service personnel under the following conditions:
 - a. When the power cord or plug is damaged or frayed.
 - b. If liquid has been spilled into the appliance.
 - c. If the appliance has been exposed to rain or water.
 - d. If the appliance does not operate normally by following the operating instructions. Adjust only those controls that are covered by the operating instructions as improper adjustment of other controls may result in damage and will often require extensive work by a qualified technician to restore the appliance to normal operation.
 - e. If the appliance has been dropped or the cabinet has been damaged.
 - f. When the appliance exhibits a distinct change in performance - this indicates a need for service.
18. When replacement parts are required, be sure the service technician has used replacement parts specified by the manufacturer that have the same characteristics as the original part. Unauthorized substitutions may result in fire, electric shock, or other hazards.
19. Upon completion of any service or repairs to this appliance, ask the service technician to perform routine safety checks to determine that the appliance is in safe operating condition.

PORTABLE CART WARNING
(symbol provided by RETAC)



SAFETY PRECAUTIONS (for USA)

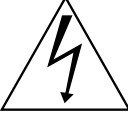

CAUTION

RISK OF ELECTRIC SHOCK DO NOT OPEN



CAUTION: TO REDUCE THE RISK OF ELECTRIC SHOCK, DO NOT REMOVE COVER (OR BACK). NO USER-SERVICEABLE PARTS INSIDE. REFER SERVICING TO QUALIFIED SERVICE PERSONNEL

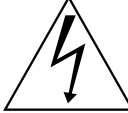

ATTENTION

RISQUE D'ELECTROCUTION NE PAS OUVRIR



ATTENTION: POUR EVITER TOUT RISQUE D'ELECTROCUTION NE PAS OUVRIR LE BOITER. AUCUNE PIECE INTERIEURE N'EST A REGLER PAR L'UTILISATEUR. SE REFERER A UN AGENT QUALIFIE EN CAS DE PROBLEME.

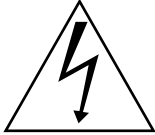

The lightning flash with arrowhead symbol, within an equilateral triangle, is intended to alert the user to the presence of uninsulated "dangerous voltage" within the product's enclosure that may be of sufficient magnitude to constitute a risk of electric shock to persons.



The exclamation point within an equilateral triangle is intended to alert the user to the presence of important operating and maintenance (servicing) instructions in the literature accompanying the appliance.

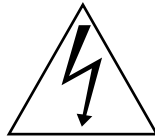

Le symbole de l'éclair à l'intérieur d'un triangle équilatéral est destiné à alerter l'utilisateur sur la présence d'une "tension dangereuse" non isolée dans le boîtier du produit. Cette tension est suffisante pour provoquer l'électrocution de personnes.



Le point d'exclamation à l'intérieur d'un triangle équilatéral est destiné à alerter l'utilisateur sur la présence d'opérations d'entretien importantes au sujet desquelles des renseignements se trouvent dans le manuel d'instructions.

* Ces symboles ne sont utilisés qu'aux Etats-Unis.

WARNING:
TO REDUCE THE RISK OF FIRE OR ELECTRIC SHOCK, DO NOT EXPOSE THIS APPLIANCE TO RAIN OR MOISTURE.
 This unit should be used with 120 V AC only.
CAUTION:
To prevent electric shocks and fire hazards, DO NOT use any other power source.

AVERTISSEMENT:
POUR EVITER LES RISQUES D'INCENDIE OU D'ELECTROCUTION, NE PAS EXPOSER L'APPAREIL A L'HUMIDITE OU A LA PLUIE.
 Ce magnétoSCOPE ne doit être utilisé que sur du courant alternatif en 120 V.
ATTENTION:
Afin d'éviter tout resque d'incendie ou d'électrocution, ne pas utiliser d'autres sources d'alimentation électrique.

NOTE:
 The rating plate (serial number plate) is on the rear of the unit.

REMARQUE:
 La plaque d'identification (numéro de série) se trouve sur le panneau arrière de l'appareil.

INFORMATION:
 This equipment has been tested and found to comply with the limits for a Class A digital device, pursuant to Part 15 of the FCC Rules. These limits are designed to provide reasonable protection against harmful interference when the equipment is operated in a commercial environment.
 This equipment generates, uses, and can radiate radio frequency energy and, if not installed and used in accordance with the instruction manual, may cause harmful interference to radio communications.
 Operation of this equipment in a residential area is likely to cause harmful interference in which case the user will be required to correct the interference at his own expense.

CAUTION:
 CHANGES OR MODIFICATIONS NOT APPROVED BY JVC COULD VOID USER'S AUTHORITY TO OPERATE THE EQUIPMENT.

NOTE:
 The rating plate (serial number plate) is on this unit.

WARNING:
 TO REDUCE THE RISK OF FIRE OR ELECTRIC SHOCK, DO NOT EXPOSE THIS APPLIANCE TO RAIN OR MOISTURE.

CAUTION:
 RED color indications on the operation panel are provided but they are not safety related, RED color indications :
 (1) For Recording Indicator
 (2) For Alarm Indicator
 (3) For Warning Indicator

THIS DEVICE COMPLIES WITH PART 15 OF THE FCC RULES. OPERATION IS SUBJECT TO THE FOLLOWING TWO CONDITIONS: (1) THIS DEVICE MAY NOT CAUSE HARMFUL INTERFERENCE, AND (2) THIS DEVICE MUST ACCEPT ANY INTERFERENCE RECEIVED, INCLUDING INTERFERENCE THAT MAY CAUSE UNDESIRE OPERATION.

SAFETY PRECAUTIONS (for Europe)

IMPORTANT (In the United Kingdom) Mains Supply (AC 220 V to 240 V) WARNING - THIS APPARATUS MUST BE EARTHED

The wires in this mains lead are coloured in accordance with the following code;

GREEN-and-YELLOW : EARTH

BLUE : NEUTRAL

BROWN : LIVE

As the colours of the wires in the mains lead of this apparatus may not correspond with the coloured markings identifying the terminals in your plug, proceed as follows.

The wire which is coloured GREEN-AND-YELLOW must be connected to the terminal in the plug which is marked with the letter E or by the safety earth symbol or coloured GREEN or GREEN-AND-YELLOW.

The wire which is coloured BLUE must be connected to the terminal which is marked with the letter N or which is coloured BLACK. The wire which is coloured BROWN must be connected to the terminal which is marked with the letter L or coloured RED.

POWER SYSTEM

Connection to the mains supply

This unit operates on voltage of 220 V to 240 V AC, 50 Hz/60 Hz.

WARNING:

TO REDUCE THE RISK OF FIRE OR ELECTRIC SHOCK, DO NOT EXPOSE THIS APPLIANCE TO RAIN OR MOISTURE.

CAUTION

To prevent electric shock, do not open the cabinet. No user serviceable parts inside. Refer servicing to qualified service personnel.

Note:

The rating plate and the safety caution are on the rear and top of the unit.

Caution for AC Power Cord

FOR YOUR SAFETY PLEASE READ THE FOLLOWING TEXT CAREFULLY.

Appropriate AC Power Cord must be used in each local area.

FOR CONTINENTAL EUROPE, ETC.

Not to be used in the U.K.

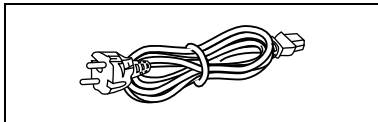

FOR U.K. ONLY

If the plug supplied is not suitable for your socket outlet, it should be cut off and appropriate one fitted.

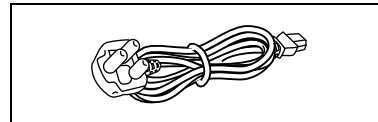

WARNING

It should be noted that it may be unlawful to re-record pre-recorded tapes, records, or discs without the consent of the owner of copyright in the sound or video recording, broadcast, or cable programme and in any literary, dramatic, musical or artistic work embodied therein.

CAUTION

RED colour indications on the operation panel are provided but they are not safety related, RED colour indications :

- (1) For Recording Indicator
- (2) For Alarm Indicator
- (3) For Warning Indicator

WARNING

This is a Class A product. In a domestic environment this product may cause radio interference in which case the user may be required to take adequate measures.

WARNING

For PLUGGABLE EQUIPMENT, the socket outlet shall be installed near the equipment and shall be easily accessible.

WARNING

It may be unlawful to record or playback copyright material without the consent of the copyright owner.

Information for Users on Disposal of Old Equipment



[European Union]

This symbol indicates that the electrical and electronic equipment should not be disposed as general household waste at its end-of-life. Instead, the product should be handed over to the applicable collection point for the recycling of electrical and electronic equipment for proper treatment, recovery and recycling in accordance with your national legislation.

By disposing of this product correctly, you will help to conserve natural resources and will help prevent potential negative effects on the environment and human health which could otherwise be caused by inappropriate waste handling of this product. For more information about collection point and recycling of this product, please contact your local municipal office, your household waste disposal service or the shop where you purchased the product.

Penalties may be applicable for incorrect disposal of this waste, in accordance with national legislation.

(Business users)

If you wish to dispose of this product, please visit our web page www.jvc-europe.com to obtain information about the take-back of the product.

[Other Countries outside the European Union]

If you wish to dispose of this product, please do so in accordance with applicable national legislation or other rules in your country for the treatment of old electrical and electronic equipment.

Attention:

This symbol is only valid in the European Union.

Dear Customer,

This apparatus is in conformance with the valid European directives and standards regarding electromagnetic compatibility and electrical safety.

European representatives of Victor Company of Japan Limited is:
JVC Technology Centre Europe GmbH
P.O. Box 10 05 52
61145 Friedberg
Germany

CAUTION

- (1) Please do not detach the front cover.
- (2) Please put it when the front cover comes off.

SICHERHEITSVORKEHRUNGEN (for Germany)

SPANNUNGSVERSORGUNG

Anschluss am Netz

Die Betriebsspannung für dieses Gerät beträgt
AC 220 V bis 240 V, 50 Hz/60 Hz

ACHTUNG:

UM DER GEFAHR VON BRÄNDEN UND ELEKTRISCHEN SCHLÄGEN VORZUBEUGEN, DARF DIESES GERÄT WEDER DEM REGEN NOCH HOHER FEUCHTIGKEIT AUSGESETZT WERDEN.

ACHTUNG

Um elektrische Schläge zu vermeiden, das Gehäuse nie öffnen. Im Innern befinden sich keine Teile, die vom Benutzer gewartet werden können. Überlassen Sie die Wartung qualifiziertem Service-Personal.

WARNUNG

Bei dem Gerät handelt es sich um ein Klasse-A-Produkt. In Haushaltsumgebungen kann ein solches Produkt Funkstörungen verursachen. In einem solchen Fall muss der Benutzer geeignete Maßnahmen ergreifen.

Sehr geehrter Kunde, sehr geehrte Kundin, dieses Gerät stimmt mit den gültigen europäischen Richtlinien und Normen bezüglich elektromagnetischer Verträglichkeit und elektrischer Sicherheit überein.

Die europäische Vertretung für die Victor Company of Japan, Limited ist:
JVC Technology Centre Europe GmbH
Postfach 10 05 52
61145 Friedberg
Deutschland

Benutzerinformationen zur Entsorgung alter Geräte

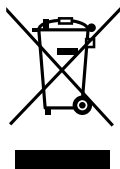

[Europäische Union]

Dieses Symbol zeigt an, dass das elektrische bzw. elektronische Gerät nicht als normaler Haushaltsabfall entsorgt werden soll. Stattdessen sollte das Produkt zur fachgerechten Entsorgung, Weiterverwendung und Wiederverwertung in Übereinstimmung mit der Landesgesetzgebung einer entsprechenden Sammelstelle für das Recycling elektrischer und elektronischer Geräte zugeführt werden.

Die korrekte Entsorgung dieses Produkts dient dem Umweltschutz und verhindert mögliche Schäden für die Umwelt und die menschliche Gesundheit, welche durch unsachgemäße Behandlung des Produkts auftreten können. Weitere Informationen zu Sammelstellen und dem Recycling dieses Produkts erhalten Sie bei Ihrer Gemeindeverwaltung, Ihrem örtlichen Entsorgungsunternehmen oder in dem Geschäft, in dem Sie das Produkt gekauft haben.

Für die nicht fachgerechte Entsorgung dieses Abfalls können gemäß der Landesgesetzgebung Strafen ausgesprochen werden.

(Geschäftskunden)

Wenn Sie dieses Produkt entsorgen möchten, besuchen Sie bitte unsere Webseite www.jvc-europe.com, um Informationen zur Rücknahme des Produkts zu erhalten.

[Andere Länder außerhalb der Europäischen Union]

Wenn Sie dieses Produkt entsorgen möchten, halten Sie sich dabei bitte an die entsprechenden Landesgesetze und andere Regelungen in Ihrem Land zur Behandlung elektrischer und elektronischer Geräte.

Erklärung zum Rauschen (für die Bundesrepublik Deutschland):
Maschinenlärminformations-Verordnung 3. GPSGV, 06.01.2004: Der höchste Schalldruckpegel beträgt 70 dB(A) oder weniger gemäß EN ISO 7779

Hinweis zum Netzanschlußkabel

Zu Ihrer Sicherheit lesen Sie bitte das folgende sorgfältig.

Verwenden Sie ausschließlich ein in Ihrem Land zulässiges Netzkabel.

Für Kontinentaleuropa

Nicht für den Gebrauch in Großbritannien.

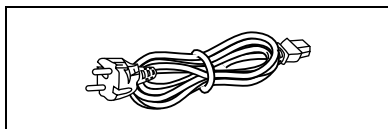

Nur für Großbritannien

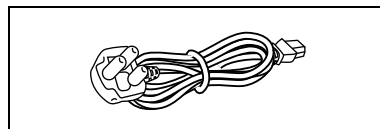

WICHTIGE SICHERHEITSHINWEISE

1. Alle Warnungen auf dem Produkt sowie in der Betriebsanleitung sind unbedingt zu beachten.
2. Ziehen Sie den Netzstecker dieses Systems aus der Steckdose, bevor Sie das Gerät reinigen. Benutzen Sie keine Flüssigreiniger und keine Sprühreiniger. Verwenden Sie zum Reinigen lediglich ein leicht angefeuchtetes Tuch.
3. Benutzen Sie keine Zubehörteile, die nicht vom Hersteller empfohlen werden; diese können Gefahren und Risiken verursachen.
4. Benutzen Sie das Gerät nicht in der Nähe von Wasser und sonstigen Flüssigkeiten - beispielsweise nicht in der Nähe von Badewannen, Handwaschbecken, Spülen, Waschbecken, nicht in feuchten Kellern, nicht in der Nähe von Schwimmbecken, und so weiter.
5. Stellen Sie das Gerät nicht auf instabile Wagen, Ständer oder Tische. Das Gerät kann herunterfallen, ernsthafte Verletzungen bei Kindern und Erwachsenen hervorrufen und auch selbst schwer beschädigt werden. Benutzen Sie ausschließlich Wagen oder Ständer, die vom Hersteller empfohlen oder mit dem Gerät verkauft wurden. Bei der Aufstellung im Regal halten Sie sich an die Anweisungen des Herstellers. Zusätzlich sollten Sie einen vom Hersteller zugelassenen Montagesatz verwenden. Eine Kombination aus Gerät und Wagen sollte grundsätzlich mit großer Sorgfalt bewegt werden. Schnelle Stopps, übermäßiger Krafteinsatz und unebener Untergrund können zum Umkippen der Gerät-Wagen-Kombination führen.
6. Schlitze und Öffnungen im Gehäuse sowie an Rückwand und Unterseite dienen der Belüftung des Gerätes und sorgen dafür, dass das Gerät zuverlässig arbeiten und sich nicht überhitzen kann. Daher dürfen Sie diese Öffnungen auf keinen Fall blockieren oder abdecken. Die Öffnungen können beispielsweise blockiert werden, wenn Sie das Gerät auf ein Bett, ein Sofa, einen Teppich oder einen ähnlichen Untergrund stellen. Dies darf auf keinen Fall geschehen. Das Gerät sollte niemals in der Nähe oder über Heizgeräten oder anderen Geräten, die Wärme abstrahlen, aufgestellt werden. Geschlossene Aufstellungsorte wie Bücherregale eignen sich nur dann zur Aufstellung des Gerätes, wenn eine ordnungsgemäße Belüftung jederzeit gewährleistet ist.
7. Das Gerät ist mit einem Schutzkontaktstecker (einem Stecker mit Erdungsbügeln an beiden Seiten) ausgestattet. Dieser Stecker lässt sich nur in eine geerdete Schutzkontaktsteckdose einstecken. Dies dient Ihrer Sicherheit. Falls sich der Stecker nicht problemlos in die Steckdose einstecken lassen sollte, lassen Sie die (veraltete) Steckdose von einem Elektriker austauschen. Versuchen Sie niemals, die Sicherheit, die Ihnen ein Schutzkontaktstecker bietet, auf irgendeine Weise außer Kraft zu setzen.
8. Um das Gerät während eines Gewitters oder für einen längeren unbeaufsichtigten Zeitraum zu schützen, ziehen Sie den Netzstecker aus der Steckdose, und trennen Sie die Antenne oder das Kabelsystem ab. Dadurch vermeiden Sie Produktschäden, die als Folge eines Blitzeinschlags oder Stromstosses auftreten können.
9. Sorgen Sie dafür, dass nichts auf dem Netzkabel zu liegen kommt. Platzieren Sie das Gerät nicht an Stellen, an denen Personen auf das Kabel treten und es beschädigen können.
10. Beachten Sie alle Warnungen und Anleitungen, die auf dem Gerät vermerkt sind.
11. Überlasten Sie niemals Steckdosen oder Verlängerungskabel: Dies kann leicht zu Stromschlägen und Bränden führen.
12. Stecken Sie niemals Gegenstände gleich welcher Art durch die Gehäuseöffnungen in das Gerät; dabei können Hochspannung führende Teile berührt und Kurzschlüsse verursacht werden: Es besteht akute Brand- und Stromschlaggefahr. Lassen Sie niemals Flüssigkeiten gleich welcher Art auf oder in das Gerät gelangen.
13. Unter folgenden Bedingungen ziehen Sie den Netzstecker und lassen das Gerät von einem qualifizierten Techniker überprüfen und reparieren:
 - a. Wenn das Netzkabel oder der Netzstecker beschädigt ist; auch kleinste Beschädigungen können große Auswirkungen haben.
 - b. Falls Flüssigkeit auf oder in das Gerät gelangt sein sollte.
 - c. Wenn das Gerät mit Regen oder Wasser in Berührung gekommen ist.
 - d. Wenn das Gerät nicht normal funktioniert, obwohl die Betriebsanleitung befolgt wurde. Passen Sie nur die Steuerungen an, die in der Betriebsanleitung vermerkt sind. Die Anpassung anderer Steuerungen kann ansonsten zu Schäden führen, die dann sehr aufwändig von einem qualifizierten Techniker repariert werden müssen, damit das Gerät wieder einwandfrei funktioniert.
 - e. Falls das Gerät fallen gelassen oder das Gehäuse beschädigt wurde.
 - f. Falls sich die Leistung des Gerätes spürbar ändern sollte - in diesem Fall muss das Gerät dringend überprüft und/oder repariert werden.

ACHTUNG

(1) Nehmen Sie nicht die Frontabdeckung ab.

(2) Falls sich die Frontabdeckung lösen sollte, setzen Sie sie sofort wieder auf.

Lager- und Verwendungsort:

■ Vermeiden Sie, den Recorder an folgenden Plätzen zu lagern oder zu verwenden.

Eine Missachtung kann zu einem Fehler oder einer Störung führen.

- Extrem heiÙe oder kalte Plätze, die auÙerhalb der zulässigen Betriebstemperatur liegen (5°C – 40°C)
- Feuchte oder trockene Plätze, die auÙerhalb der zulässigen Feuchtigkeit für den Betrieb liegen (30% – 80%)
- Plätze, an denen starke Magnetfelder erzeugt werden, beispielsweise Transformatoren oder Motoren
- Plätze in der Nähe von Geräten, die elektrische Wellen erzeugen, beispielsweise Sender-Empfänger oder Handys
- Staubige oder sandige Plätze
- Plätze, die starken Erschütterungen ausgesetzt sind
- Plätze, die zu Kondensationsbildung neigen, beispielsweise ein Fenster
- Plätze, die Strahlung, Röntgenstrahlen oder ätzende Gase erzeugen

Handhabung des Recorders:

■ Stapeln Sie Recorder nicht aufeinander. Dies kann zu erhöhter Geräuschentwicklung und aufgrund von Überhitzung zu Fehlfunktionen oder zum Totalausfall der Geräte bis hin zu Bränden führen.

■ Blockieren Sie nicht die Belüftungsschlitze. Sind die Öffnungen blockiert, bildet sich im Inneren des Recorders Hitze, wodurch ein Brand entstehen kann. Benutzen Sie den Recorder nicht in vertikaler Position, nicht auf dem Kopf stehend, nicht mit der Front nach oben.

■ Legen Sie keine Gegenstände auf dem Recorder ab. Wenn Sie einen schweren Gegenstand, beispielsweise einen Fernsehbildschirm oder einen großen Gegenstand, der über die Kante des Recorders hinausragt, auf den Recorder stellen, kann dieser aus dem Gleichgewicht geraten. Dadurch besteht die Gefahr, dass der Recorder kippt oder auf den Boden fällt und Verletzungen verursacht.

■ Steigen Sie nicht auf den Recorder. Der Recorder könnte umfallen oder beschädigt werden. Achten Sie besonders auf kleine Kinder.

■ Stellen Sie keine wasserhaltigen Gegenstände auf dem Recorder ab (beispielsweise Vase, Blumentopf, Gläser, Kosmetika oder Chemikalien). Tritt Wasser in das Innere des Recorders ein, kann dies einen Brand oder einen Kurzschluss verursachen.

■ Stecken Sie keine Fremdkörper in den Recorder. Dringen metallische oder brennbare Gegenstände durch die Belüftungsschlitze o.ä. in den Recorder ein, kann dies einen Brand oder einen Kurzschluss verursachen.

Pflege des Recorders

■ Wischen Sie den Recorder mit einem weichen Tuch ab.

Verwenden Sie keine Verdüner oder Benzol. Dies könnte dazu führen, dass die Oberfläche zersetzt oder matt wird. Im Fall von hartnäckigen Flecken, wischen Sie diese zunächst mit einem neutralen und mit Wasser verdünnten Reiniger ab, und wischen Sie die Fläche dann trocken.

Transport des Recorders

■ Trennen Sie vor dem Transport des Recorders alle Kabel ab. Schalten Sie den Recorder vor dem Transport aus und stellen Sie sicher, dass der Netzstecker aus der Steckdose entfernt wurde. Wird dies nicht beachtet, kann dies zu Beschädigungen am Kabel, einem Brand oder einem Stromschlag führen.

■ Transportieren oder starten Sie die Installation des Recorders nicht, solange er noch eingeschaltet ist oder unmittelbar nachdem er ausgeschaltet wurde (ungefähr eine Minute).

■ Achten Sie bei der Verpackung darauf, dass der Recorder vor Stößen geschützt ist.

■ Gehen Sie vorsichtig mit dem Recorder um. Setzen Sie ihn keinesfalls Erschütterungen oder Stößen aus.

Netzkabel

- Verwenden Sie das mit dem Recorder gelieferte Netzkabel ausschließlich für dieses Gerät.
- Stellen Sie keine schweren Gegenstände auf das Netzkabel und vermeiden Sie, dass das Netzkabel unter dem Recorder eingeklemmt wird. Wird dies nicht beachtet, kann dies zu Beschädigungen am Kabel, einem Brand oder einem Stromschlag führen.
- Benutzen Sie grundsätzlich das mit dem Recorder gelieferte Netzkabel. Die Verwendung eines anderen oder beschädigten Kabels kann zu Stromschlägen und Bränden führen.
- Stecken Sie das Netzkabel nicht während der Aufnahme, Wiedergabe oder während eines Zugriffs auf das Laufwerk aus.

Hinterer Gehäusedeckel: Achtung:

Sämtliche Audio-, Video- und LAN-Verbinder dürfen nicht direkt an ein Kabelverteilungssystem (Außenbereiche oder zwischen Gebäuden) angeschlossen werden.

Hintere E/A-Terminals: Hinweis: Verwenden Sie dieses Terminal nicht für eine Sicherungserdung.

Einbau des VR-N1600E in einem EIA-Rack mit Montageklammern:

- 1 Montieren Sie die seitliche Klammer mit M4-Schrauben an der rechten und linken Seite. Diese Schrauben sind im Lieferumfang des VR-N1600E enthalten.
- 2 Entfernen Sie 4 Schrauben und 4 Füße vom Boden des VR-N1600E.
- 3 Befestigen Sie diese mit M5-Schrauben am Rack. Diese Schrauben sind im Lieferumfang des VR-N1600E enthalten.

Achtung

- Stellen Sie keinerlei Gegenstände auf den VR-N1600E, wenn dieser in einem Rack montiert ist. Dies kann durch Ungleichgewicht zum Herunterfallen des Recorders führen und Verletzungen oder Schäden verursachen.
- Werden zwei oder mehrere Recorder in dem Rack eingebaut, achten Sie darauf, dass der Abstand mindestens die Größe eines Recorders beträgt.
- Bauen Sie den VR-N1600E nicht in ein Rack ein, wenn die Umgebungstemperatur 40°C oder mehr beträgt.
- Achten Sie beim Einbau in einem Rack darauf, dass die Innentemperatur der Rack-Einheit 40°C oder weniger beträgt.
- Wenn Sie das Gerät in einem Rack montieren, halten Sie einen Abstand von mindestens 15 cm zwischen Rack und der Rückwand des Gerätes ein.

Beachten Sie im Fall eines Einbaus oder Wartung dieses Geräts in einem Rack die speziellen Vorsichtsmaßnahmen, um sicherzustellen, dass das System nicht an Stabilität verliert.

Folgende Richtlinien dienen zur Sicherstellung Ihrer Sicherheit.

Ist dieses Gerät die einzige Einheit, die in dem Rack einzubauen ist, so sollte es auf dem Rack-Boden angebracht werden. Wird das Rack teilweise genutzt, bauen Sie die Teile von unten nach oben ein. Die schwerste Komponente sollte stets unten im Rack eingebaut werden. Ist das Rack mit stabilisierendem Zubehör ausgestattet, montieren Sie zunächst diese Stabilisatoren, bevor Sie das Gerät in das Rack einbauen oder warten.

Achtung:

Vor dem Einbau in das Rack ist sicherzustellen, dass das Rack sicher und vor dem Umfallen geschützt ist.

Technische Daten:

Allgemein:

Zulässiger Temperaturbereich bei der Lagerung: -20 °C bis 60 °C

Stromaufnahme: 0,8 A (max.)

Gewicht: etwa 7,8 kg

Features

Automatic detection of network cameras

Reduces the hassle of complex camera registration procedures.

Built-in large-capacity hard disk (500 GB)

HDD expansion supported

Addition of up to 500 GB (built-in), 2 TB x 2 units (external.)

RAID1 supported

Supports RAID1 if additional built-in HDD is installed. Writing the same data to two separate hard disks (mirroring) to enable normal use if one of the hard disks breaks down.

Simultaneous recording up to 16 channels at 160 ips

Simultaneous recording up to 16 channels at 240 ips is possible when the NVR Viewer is not started up. In addition, purchasing additional camera licenses enables the VR-N1600U/E(A) to handle simultaneous recording up to 32 channels. For details, please consult your nearest JVC dealer.

Display/Distribution performance at 80 ips (VR-N1600U/E) and 160 ips (VR-N1600U/E(A))

Enables simultaneous recording and playback

Playback of recorded images, jog dial playback and skip playback are possible while recording is in progress.

Direct Search

Enables you to retrieve data of a specific date/time or alarm position speedily.

Power failure recovery record

If a power failure occurs during recording, the system resumes recording in the mode selected before the power failure after recovery.

Alarm recording

Enables recording to start automatically in the alarm recording mode when alarm signal input is received during recording.

Motion Detect

Enables recording to start automatically when "motion" is detected in the preset live image. You can also specify the detection area for each camera.

Alarm Mail Notification

Enables notification by e-mails to be sent out when an alarm or motion is detected.

How to Read this Manual

■ VR-N1600U/E Documents

There are two documents on this unit.

(1) Startup Guide

This is a booklet that is supplied together with VR-N1600U/E. It is also available in the PDF file format. You can find it in the CD-ROM provided.

(2) Instruction Manual (PDF)

This manual is available in the PDF file format. You can find it in the CD-ROM provided.

■ Symbols Used in this Manual

Note	Precautions to take during operation of this unit.
Memo	Details for reference, such as functions and restrictions on uses.
	Page or item to refer to.

■ Content of this Manual

- The copyright of this manual belongs to JVC. Reproduction or copy of this manual, in part or in whole, without the prior consent of JVC is strictly prohibited.
- Product names used in this manual are the trademarks or registered trademarks of the respective companies. Symbols such as ™, ®, © and are omitted in this manual.
- Milestone and XProtect Enterprise are the registered trademarks of Milestone Systems, Inc.
- Designs, specifications and other details used in this manual may be modified for improvement without prior notice.

This STARTUP GUIDE deals only with the initial setup and basic operational procedures on the VR-N1600U/E.

Besides the STARTUP GUIDE, the VR-N1600U/E INSTRUCTIONS is also provided on a CD-ROM that explains further details on the operation procedures. For details, please refer to the CD-ROM.

Contents

Getting Started

Features	2
Contents	3
Precautions for Proper Use of this Product	4
Part Names and Functions	6
Mounting to a Rack	10

Preparation

System Connection Example	11
During Initial Startup	12

Basic Operation

Viewing Live Images via Front Panel Control	16
Displaying the [Live] Screen	16
Select a View	16
Select a Camera	16
Operating the Camera	17
Playing Back Recorded Images	
via Front Panel Control	18
Select a View	18
Searching Recorded Image	
Using a Specific Date/Time	18
Playing, Skipping and Stopping Recorded Images	18
Adjusting the Playback Speed	
(Jog/Shuttle Playback)	19

Others

Troubleshooting	20
Specifications	21

Precautions for Proper Use of this Product

Locations of Storage and Use

- Do not store the unit at the following places. Doing so may cause the unit to malfunction or break down.
 - Hot or cold places beyond the allowable operating temperature (5 °C to 40 °C)
 - Humid places beyond the allowable operating humidity (30%RH to 80%RH) (no condensation)
 - Places that emit a strong magnetic field, such as near transformers and motors
 - Places near devices that emit radio waves, such as transceivers and mobile phones
 - Places with considerable dust and sand
 - Places with strong vibrations
 - Places where water droplets may be formed, such as window sills
 - Places with considerable vapor and oil, such as kitchens
 - Places that emit radiation, X-rays, and corrosive gases
- Using this unit and the cable that is connected to it near places where strong radio waves or magnetic fields (such as near radios, TVs, transformers, and monitors) are emitted may cause noises in the video images or color changes.

Handling Precautions

- Do not stack the devices on one another during use. Heat and noise from the devices may cause the unit to malfunction or break down, and lead to fire.
- Do not block the ventilation holes. Doing so may cause heat to trap inside the unit and result in fire. Do not use this unit by laying it down sideways, upside down, or at an angle.
- Do not place objects on this unit. Placing heavy objects, such as TV monitors, or objects that are bigger in size on this unit may cause it to lose balance and drop or fall, hence resulting in injuries.
- Do not stand or sit on this unit. Doing so may cause this unit to fall or break down, and result in injuries. Keep it out of the reach of young children.
- Do not place objects with water (e.g., vases, flower pots, cups, cosmetic products, and chemicals) on this unit. Water may enter this unit and result in fire or electric shock.
- Do not insert objects into this unit. Metallic or other flammable objects that enter this unit from the ventilation holes may result in fire or electric shock.

Precautions for Handling Hard Disk Drive

- The distance between the head and the disk is only about 0.02 μm when the hard disk (henceforth HDD) is reading the data. Vibration or impact that is exerted on the HDD may therefore cause the head to hit against the disk, hence causing the disk surface to dent or the disk to chip. When this occurs, data may not be properly read, or in a worse scenario, continued use in this condition may result

in head crash (damage). Careful attention must therefore be paid when handling it.

- Precautions During Installation and Change of Installation Location

Moving of this unit or installation work is strictly prohibited when the power of this unit is on or immediately after the power is turned off (approximately 1 minute). (The HDD continues to move under its own inertia for some time after the power is disconnected, and exertion of vibration or impact during this interval may result in HDD failure.) When moving this unit, wrap it using cushioning materials to protect it from external shock.
- Handling Precautions
 - Handle this unit carefully without exerting vibration or impact on it.
 - Do not remove the power plug during recording or playback, or when the HDD is being accessed.
 - The HDD is a consumable product. Perform maintenance after it has been used for about 18,000 hours. (This value is based on its use in an environment with a temperature of 25 °C, and may vary according to the environment of use.) For inquiries on maintenance plans and expenses, consult your nearest JVC dealer listed on the separate sheet.
- When installing an external hard disk, we recommend the use of UPS (uninterruptible power supply) to ensure the stable operation of the system.
- Power failure that occurs during formatting or disconnection of the HDD may affect its subsequent use even when the UPS is connected.
- JVC shall not be held responsible for the compensation of losses incurred in the event that recording or playback fails due to defects in this unit or its hard disk drive.
 - Images recorded on the HDD will be deleted when you replace it with a new disk. Note also that recorded images may be deleted when you upgrade the software for this unit.

Precautions when Moving this Unit

- Remove all connected cords before moving
Turn off the power and remove the power plug before moving this unit. Failure to do so may cause damage on the cords, and result in fire or electric shock.
- Moving of this unit or installation work is strictly prohibited when the power of this unit is on or immediately after the power is turned off (approximately 1 minute).
The HDD continues to move under its own inertia for some time after the power is disconnected, and exertion of vibration or impact during this interval may result in HDD failure.
- When moving this unit, wrap it using cushioning materials to protect it from external shock.
- Handle this unit carefully without exerting vibration or impact on it.

Precautions for Handling Power Cords

- Do not use the supplied cords on devices other than this unit.
- Do not place heavy objects on the power cord, or place it under this unit
Doing so may cause damage on the cords, and result in fire or electric shock.
- Do not use cords other than those supplied with this unit
Use only power cords supplied together with this unit. Using cords with different withstanding voltage specifications or damaged cords may result in fire or electric shock.
- Do not remove the power plug during recording or playback, or when the HDD is being accessed.

Maintenance

- Turn off the power before performing maintenance of this unit.
- Wipe this unit using a soft cloth. Wiping using thinner or benzene may cause the surface to melt or fog. When the surface is extremely dirty, wipe using a cloth that is dipped into a neutral detergent diluted with water, followed by wiping with a dry cloth.

Energy Conservation

- Turn off the power of the system for safety reasons and to save energy if this unit is not to be used for a long time.

Copyright

- Use of video or audio sound recorded using this unit for commercial purposes or playing them for public viewing or listening may be an infringement of the copyrights of their respective authors under the copyright law.
- These video (audio) recordings shall only be restricted to personal uses, and their use without prior consent of the copyright holder is strictly prohibited under the copyright law.

Others

- When there is variation in the supply voltage such as during lightning, operation of this unit may be disabled to protect the system until the supply voltage stabilizes again.

- Eliminate static electricity before performing work that requires you to touch the input/output terminals, such as when installing devices.
- Do not touch the rear panel of this unit when it is running as static electricity may cause it to malfunction.
- When there is a large number of data recorded on this unit, such as short alarm records, a longer time may be required during search or backup. This is not a malfunction.
- Data recorded from TV broadcasts or video (audio) recordings shall only be restricted to personal uses, and their use without the prior consent of the copyright holder is strictly prohibited under the copyright law.
- The width of the border lines (black in color) of images on the split screen varies according to the type of input signals. This is due to the characteristics of the camera's input signals, and is not a malfunction. The condition may also be improved by adjusting this unit. For details, consult your nearest JVC dealer.
- This unit comes with a high-precision hard disk device. Be careful not to exert vibration or impact on this unit when handling it.
- Exertion of vibration or impact particularly when the power is on or when the hard disk is being accessed may cause this unit to break down.
- When moving this unit, do so about 1 minute after disconnecting the power supply.
- Do not turn off the power switch at the rear of this unit or unplug the power cord during recording or playback, or when the hard disk is being accessed. Otherwise, it may break down.

When this device is used as a general household, there is a possibility of radio disturbance to the radio and television receiver etc.

Part Names and Functions

Front

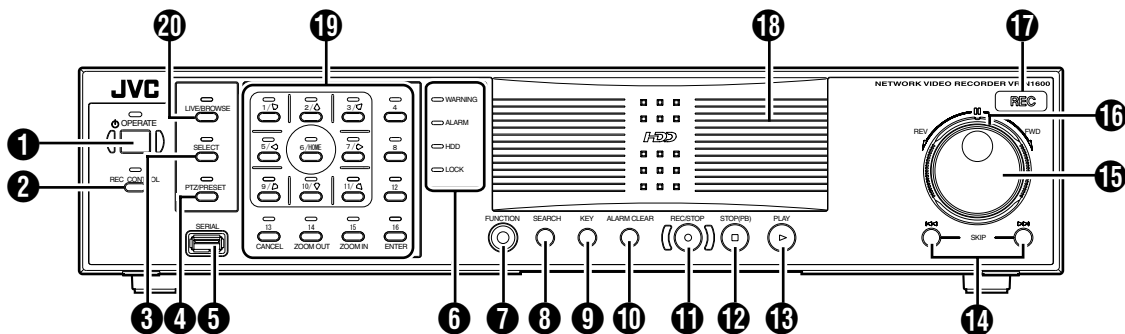

1 [OPERATE] Button/Indicator

Switches operation on or off. Press the button to turn operation “ON” and hold down the button to turn operation “OFF”. The indicator blinks while the recorder is starting up or shutting down.

2 [REC CONTROL] Button/Indicator

Switches the recording control mode on or off. The indicator lights up when the recording control mode is set to on.

Press and hold the [FUNCTION] button, and press the [REC CONTROL] button at the same time to display the menu.

Memo :

- The main menu cannot be displayed in the recording control mode or during recording.
- The recording control mode performs recording in accordance with the settings in the [Camera Record Setting] menu.

3 [SELECT] Button/Indicator

Use the 10 key to set to the camera selection mode. The indicator lights up when the camera selection mode is set to on.

4 [PTZ/PRESET] Button/Indicator

Switches between the PTZ mode and PRESET mode of the 10 key. The mode changes each time the button is pressed. The indicator lights up when PTZ mode is selected and blinks when PRESET mode is selected.

5 [SERIAL] Terminal

For connecting the communication control terminals on a mouse (sold separately), flash memory (sold separately) or UPS (sold separately).

Memo :

- Use the [SERIAL1 to 4] port on the rear panel for additional hard disk drive connection. (Page 8)

Note :

- Attach the serial port cover supplied when the port is not in use.
- Static electricity may cause the unit to malfunction. Remove any static electricity before starting operation.

6 Status indicators

■ [WARNING] Indicator

Lights up when an error occurs. (Page 20)

Press and hold the [ALARM CLEAR] button to turn off the light.

■ [ALARM] Indicator

Lights up when an alarm is activated.

Goes off when the [ALARM CLEAR] button is pressed.

■ [HDD] Indicator

Lights up when the built-in hard disk drive is accessed.

■ [LOCK] Indicator

Lights up when operation is locked.

7 [FUNCTION] Button

Press the following buttons while holding down the [FUNCTION] button to use the following features.

[FUNCTION] +[OPERATE]	Press and hold to forcibly shut down the system.
[FUNCTION] +[REC CONTROL]	Displays the main menu.
[FUNCTION] +[LIVE/BROWSE]	Reboots the NVR Viewer and the internal distribution server. Press and hold to log out.
[FUNCTION] +[5]	For controlling the PTZ camera.
[FUNCTION] +[6]	Displays the maintenance information screen.
[FUNCTION] +[8]	Sets whether to display the HDD meter or not.

8 [SEARCH] Button

Displays the date and time search screen when in the playback mode. (Page 18)

9 [KEY] Button

Press to display or hide the “software keyboard”.

Memo :

- Use the software keyboard to input characters.

10 [ALARM CLEAR] Button

Clears the [ALARM] display when an event occurs or motion is detected. Press and hold this button to turn off the [WARNING] indicator.

11 [REC/STOP] Button

Press to start recording in all cameras. (When in the recording control mode, pressing this button exits the recording control mode and starts recording on all cameras.) To stop recording, press and hold the button.

When in the recording control mode, press and hold this button to exit the recording control mode.

Memo : _____

- The manual recording mode executes recording from all cameras regardless of the settings in the [Camera Record Setting]. Recording is carried out in accordance with the frame rate selected in [Camera Record Setting].

12 [STOP(PB)] Button

Stops playback when you press this button in the playback mode.

13 [PLAY] Button

Plays back at the speed and in the direction specified by the Shuttle Dial position.

14 [SKIP] Button

■ [S]

Press to move the item selection in the reverse direction in the menu or settings screen. Jumps to the beginning of the previous sequence on the selected camera when you press this button in the playback mode. Press and hold it to jump to the first image in the database of the selected camera.

■ [T]

Press to move the item selection in the forward direction in the menu or settings screen. Jumps to the beginning of the next sequence on the selected camera when you press this button in the playback mode. Press and hold it to jump to the last image in the database of the selected camera.

Memo : _____

- "Sequence" indicates a certain block of images that are recorded during motion detection.
- Recorded images are stored in the database. "Database" refers to data recorded in this unit.

15 Jog dial

Plays back a single frame when it is rotated in the playback mode.

16 Shuttle dial

The position of the dial specifies the playback speed and playback direction when in the playback mode. Playback speed is selectable from x 1/20, x 1/5, x 1, x 2, x 5, x 10 and x 20 according to the angle.

17 [REC] Indicator

Lights up during recording. Flashes during EMERGENCY or EXT REC IN recording.

18 Center panel

Do not remove the cover.

19 Keypad buttons/Indicator

[0] to [16]

● Login screen

- For entry of passwords (numeric characters). (Enter number using [1] to [10/0] buttons. "0" is input when [10/0] button is pressed.)

● Setting screens on the main menu

- **PTZ mode Keypad**
For selecting a menu item. ([2/↑], [10/0/↓])
- **Camera selection keypad mode**
For entering numeric characters. (Enter number using [1] to [10/0] buttons. "0" is input when [10/0] button is pressed.)

● Live image display and recorded image playback screens

- **Camera selection keypad mode**
For selecting a camera number. Upon selecting, the indicator corresponding to the selected camera input lights up.

● PTZ keypad mode (live image display screen only)

Moves the camera in the direction indicated by the arrow. ([1/↖][2/↑][3/↗][5/←][7/→][9/↘][10/0/↓][11/↙])
Use the [6/HOME] button to move the camera to the home position.

● Preset keypad mode (live image display screen only)

For selecting the preset position. ([1] to [9]. 10 to 19 can be selected when [10/0/↓] is pressed at first.)

● During search for recorded images

For narrowing down the search using a date, month, week, or time.

- (Enter number using [1] to [10/0] buttons. "0" is input when [10/0] button is pressed.)

● During display of software keyboard

● Selection keypad mode

For entering numeric characters. ("0" is input when the [1/↖] to [10/0/↓] and [10/0/↓] buttons are pressed.)

● PTZ keypad mode (live image display screen only)

Moves the mouse pointer in the direction indicated by the arrow. Press [1/↖][2/↑][3/↗][5/←][7/→][9/↘][10/0/↓][11/↙] or [6/HOME] to move to the center of the screen.)

[13/CANCEL]

● Setting screens on the main menu

Cancels the selection.

[14/ZOOM OUT]

● Live image display and recorded image playback screens

● PTZ keypad mode (live image display screen only)

Zooms out.

● Preset keypad mode

For selecting the next view.

- Press the [14/ZOOM OUT] button while holding down the [FUNCTION] button to change the resolution of VGA output.

[15/ZOOM IN]

● Live image display and recorded image playback screens

● PTZ keypad mode (live image display screen only)

Zooms in.

● Preset keypad mode

For selecting the previous view.

- Press the [15/ZOOM IN] button while holding down the [FUNCTION] button to change the resolution of VGA output.

[16/ENTER]

● Setting screens on the main menu

Confirms the selection.

● During display of software keyboard

To perform the mouse click operation.

20 [LIVE/BROWSE] Button/Indicator

Switches between the [Live] mode and [Browse] mode.

The indicator lights up when in the [Live] mode.

Pressing the [LIVE/BROWSE] button when the wallpaper screen is displayed shows the [Live] screen.

Press and hold the [FUNCTION] button, and press the [LIVE/BROWSE] button at the same time to reboot the NVR Viewer and the internal distribution server.

Press and hold the [FUNCTION] button, and press the [LIVE/BROWSE] button at the same time to log out of the system.

Memo : _____

- When [Auto Logon] is enabled, the login operation starts automatically immediately after logging out.

Part Names and Functions (continued)

Rear Panel

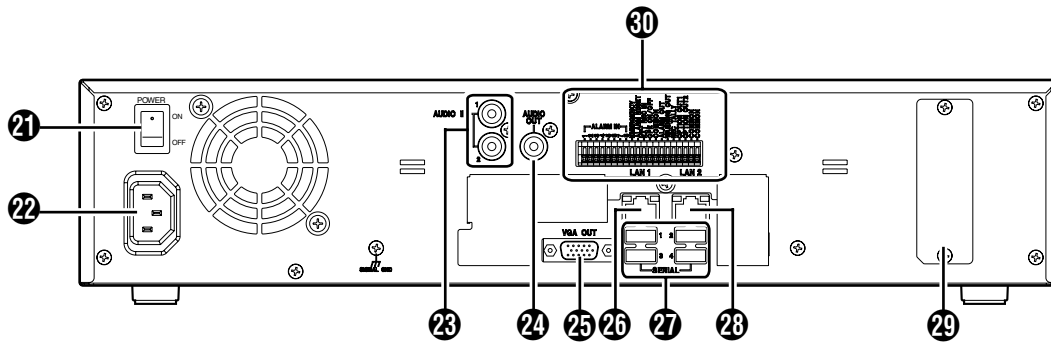

21 [POWER] switch

Switches the power on or off.

Memo : _____

- Be sure to press and hold down the [OPERATE] button on the front panel to shut down the system before switching off the power supply.

22 [AC IN] power input terminal

Connect to an AC outlet using the power cable supplied.

23 [AUDIO IN 1/AUDIO IN 2] audio input terminals 1/2 (RCA)

Connect to the audio output terminal of the device from which audio signals are to be recorded.

24 [AUDIO OUT] audio output terminal (RCA)

Outputs live sound in the live viewing mode.
Outputs recorded sound in the playback mode.

Memo : _____

- There is no audio output when playing back still images, when running searches other than x1, or when playing back frame-by-frame.

25 [VGA OUT] VGA output terminal

Outputs live images, recorded images and the menu screens.

26 [LAN1] LAN1 connection terminal (camera network)

For connecting to the IP camera (sold separately) network using a LAN cable.

	Color	Status	
Left Indicator		Off	Communication at 10 Mbit/second.
	Green	On	Communication at 100 Mbit/second.
	Orange	On	Communication at 1 Gbit/second.
Right Indicator		Off	Not connecting to the network.
	Yellow	Blinking	Communication is in progress.

27 [SERIAL1 to 4] serial terminals 1 to 4

For connecting the communication control terminals on a mouse (sold separately), flash memory (sold separately), UPS (sold separately) or additional disk drive (sold separately).

28 [LAN2] LAN2 connection terminal (Intranet)

For connecting to the remote PC network using a LAN cable.

	Color	Status	
Left Indicator		Off	Communication at 10 Mbit/second.
	Green	On	Communication at 100 Mbit/second.
	Orange	On	Communication at 1 Gbit/second.
Right Indicator		Off	Not connecting to the network.
	Yellow	Blinking	Communication is in progress.

29 Connector cover

Memo : _____

- Do not remove the cover.

30 Signal input/output terminals

For operating VR-N1600U/E using external alarm signals or signals received from external devices, or for operating external devices by outputting signals.

Memo : _____

- Diameter of applicable cables: AWG22 to AWG28

Rear I/O Terminals

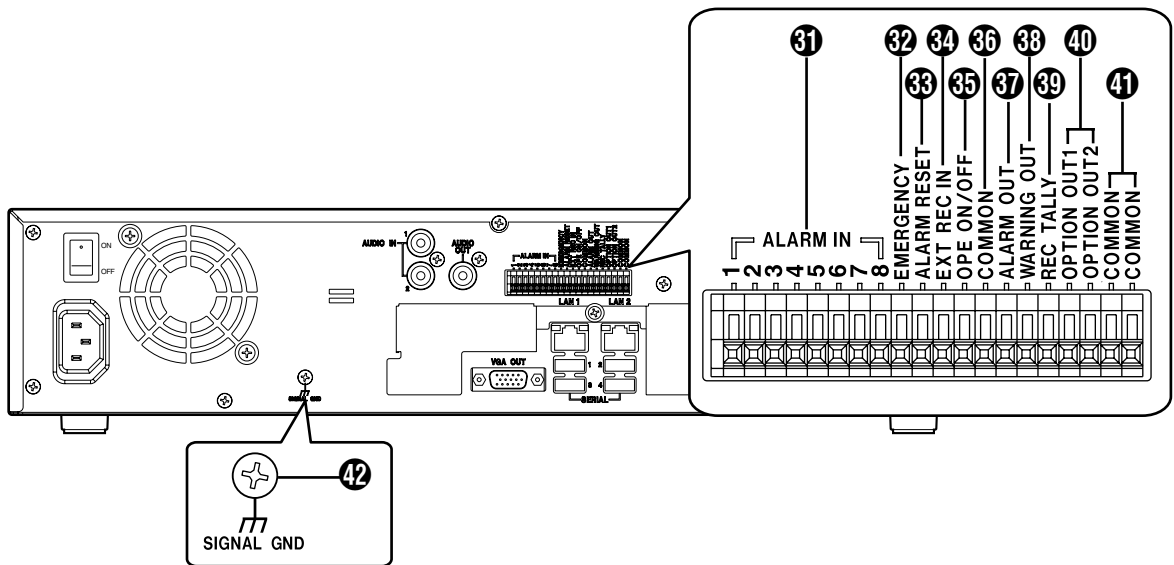

■ Input ports

① [ALARM IN 1 to 8] alarm input terminals 1 to 8

Alarm recording is activated when signals are input to these terminals.

② [EMERGENCY] emergency input terminal

Recording is activated in all cameras when a signal is input to this terminal.

③ [ALARM RESET] alarm reset input terminal

Output from the alarm output terminal is stopped when a signal is input during output of the Alarm Out signals.

Turns off the [ALARM] indicator ① on the main unit. Press and hold the button to turn off the [WARNING] indicator ⑥ on the main unit.

④ [EXT REC IN] external recording input terminal

Recording in all cameras is started or stopped by an external signal. Recording will not be started in cameras to which no video signal is being input.

⑤ [OPE ON/OFF] Operate ON/OFF terminal

Switches between OPERATE ON or OFF when a signal is input.

■ Output ports

⑥ [COMMON] signal ground terminal

This is a common ground terminal. Connect it to the signal ground terminal on the connected device. (This can be used when there are insufficient common ground terminals.)

⑦ [ALARM OUT] alarm output terminal

Outputs a signal when recording is started by an alarm.

⑧ [WARNING OUT] warning output terminal

Outputs a signal when an error such as operation abnormality occurs on the hard disk.

⑨ [REC TALLY] recording status output terminal

Outputs the recording status of this unit.

⑩ [OPTION OUT1][OPTION OUT2] OPT OUT output terminals 1/2

Outputs a signal when an event is detected.

⑪ [COMMON] signal ground terminal

Same as ⑥.

⑫ [SIGNAL GND] signal ground terminal

This is a common ground terminal. Connect it to the signal ground terminal on the connected device.

(This can be used when there are insufficient common ground terminals.)

Memo : _____

- Do not use this terminal for protective earthing.

Part Names and Functions (continued)

Rear I/O Terminals

Terminal		Remarks
①[ALARM IN]	<p>Memo :</p> <ul style="list-style-type: none"> Set the impedance at the output end to 10kΩ or below. 	Make Contact Input
②[EMERGENCY] ③[ALARM RESET]	<p>Memo :</p> <ul style="list-style-type: none"> Set the impedance at the output end to 10kΩ or below. 	Make Contact Input
④[EXT REC IN]	<p>Memo :</p> <ul style="list-style-type: none"> Set the impedance at the output end to 10kΩ or below. 	Make Contact Input
⑤[OPE ON/OFF]	<p>Memo :</p> <ul style="list-style-type: none"> Set the impedance at the output end to 10kΩ or below. 	Make Contact Input
⑥[REC TALLY] ⑦[ALARM OUT] ⑧[WARNING OUT] ⑨[OPTION OUT1] ⑩[OPTION OUT2]	<p>(External Pull-up Level) The make contact is formed using the individual output terminals and the COM terminal. Turning off the power of VR-N1600U/E switches the output of the output terminals to break.</p>	Auto Collector Output (DC15V, 10 mA and below)

Mounting to a Rack

Use the supplied rack mount bracket to mount VR-N1600U/E to the EIA rack.

1 Mount the rack mount bracket using screw (1)

- Use the 4 screws (M4 x 10 mm) supplied to fasten VR-N1600U/E at the two sides.

2 Remove screws (2) of the foot (4 pcs) at the bottom

- Remove the foot.

3 Mount to the rack using screws (3)

- Use the 4 screws (M5 x 11 mm) supplied to fasten this unit to the rack.

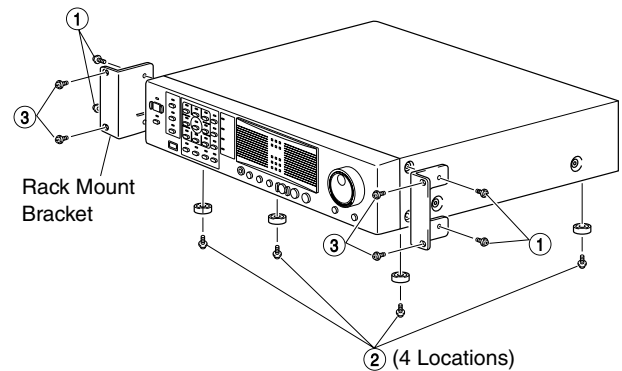

Note :

- Do not place any object on the VR-N1600U/E unit that has been mounted to the rack. Doing so may cause it to lose balance and drop or fall, hence resulting in injuries or damages.
- When mounting 2 or more units of VR-N1600U/E to the rack, make sure to mount it at a distance that is at least equivalent to one unit.

System Connection Example

The following operations are possible with this system.

- Surveillance (live image, recording and playback) by connecting up to 16 cameras
- Checking recorded images on the VGA monitor
- Recording/Playing sound
- Alarm recording
- Remote surveillance using PCs

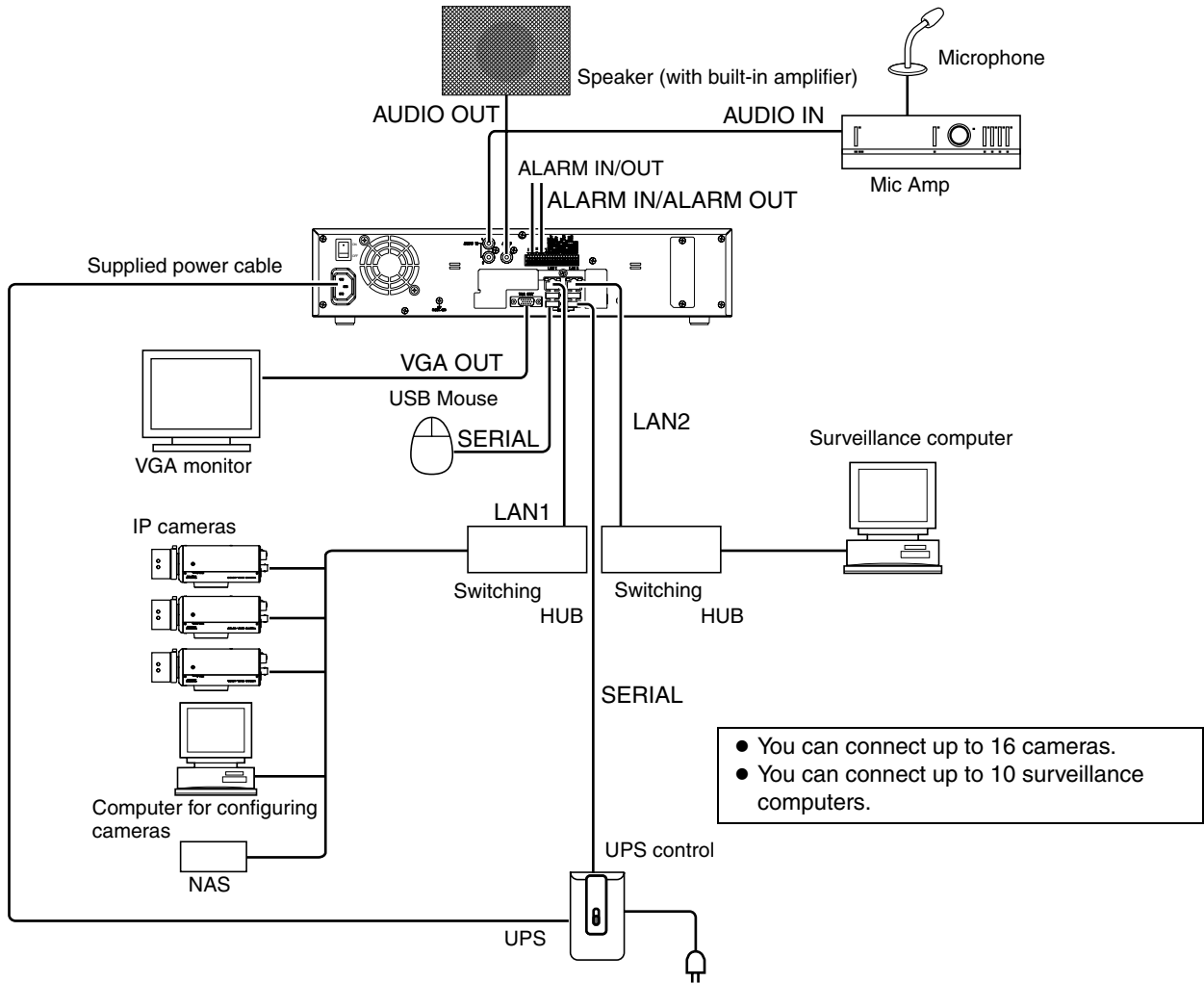

• You can connect up to 16 cameras.
 • You can connect up to 10 surveillance computers.

- Memo :**
- Connect LAN1 to the camera network.
 - LAN2 to the surveillance computer network.
 - For details of the protocol and port number for the network cameras on the LAN1 network, refer to the network camera's user manual.
 - The protocol and port number used on the LAN2 network are shown below.
 - Surveillance computer: HTTP 80
 - Mail: SMTP 25/POP 110
 - Connect NAS to the LAN1 network.

- Note :**
- Connect only after having turned "OFF" the power of all devices.
 - Set the IP address of the camera to 192.168.0.xxx. When setting the IP address of the camera to an address other than 192.168.0.xxx, you must also change the IP address of LAN1. Refer to the [Instruction Manual] of each camera for procedures to change the camera's IP address,

Preparation

System Connection Example (continued)

Note :

- Do not connect LAN1 to the internet. If the internet is busy or the relay equipment fails, you may not be able to save important camera images. To maintain full recording capacity, it is recommended that a dedicated network be used. Be sure to connect the LAN1 camera network to the same segment. (Do not use the address translation of NAT and NAPT etc. or a router.)
- If you connect LAN2 to the internet from a surveillance computer, you will need to configure IP Masquerading.
- Communication between LAN1 and LAN2 is not possible. Nor is it possible to configure a camera connected to LAN1 from the surveillance computer connected to LAN2. In order to configure a camera connected to LAN1, it is necessary to connect the computer for configuring cameras to LAN1.
- LAN1 and LAN2 are incompatible with QoS. Sound may not be played normally depending on the condition of the circuit.
- The default LAN1 IP address is 192.168.0.253 and the default LAN2 IP address is 192.168.1.253. To change the address, use [INSTRUCRTIONS].
- When a single network camera is registered with multiple units of VR-N1600U/E, recording may not be properly completed in some cases. Camera control (e.g. PTZ control) may also become unstable. It is recommended that a single VR-N1600U/E be used for registering one IP camera as well as for controlling PTZ operations.
- Do not connect a broken hub, router or deteriorated network cable etc. Doing so may prevent the system from operating properly.
- Connection to a keyboard is not recommended.

During Initial Startup

Perform language setting and automatic camera registration when starting up VR-N1600U/E for the first time.

Before Starting Up.

- The DHCP setting is required for the IP camera beforehand. Start up the VR-N1600U/E first, then switch the camera on after confirming that the [Auto Detect Setting] window is displayed.
- Refer to the user manual supplied with the camera for instructions on how to specify the IP camera settings.
- By default, [Time Zone] is set to [(GMT-05:00) Eastern Time](VR-N1600U)/[(GMT) Greenwich Mean Time](VR-N1600E) and [Auto Summertime Adjustment] is checked. Specify a Time zone according to the region used. Refer to the INSTRUCTIONS on how to specify a Time zone settings.

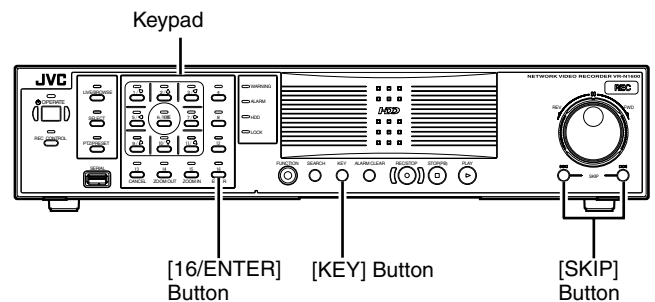

Start up VR-N1600U/E

1 Turn on the power switch at the rear panel.

- VR-N1600U/E starts up.

Selecting a Language

The [Language Setting] screen appears when you start up VR-N1600U/E for the first time. Select the language to use using the steps below.



1 Select a language

- Use the [2/↑] or [10/0/↓] button to select a language.

2 Use the [SKIP] button to select [OK], followed by pressing the [16/ENTER] button

- The “The system is being set up.” message may appear depending on the setting, and the system is automatically rebooted.

Memo :

- Selecting [OK] changes the color of the [OK] characters from brown to orange.

Automatic Registration of Cameras

After you have started up VR-N1600U/E for the first time and finished selecting a language, the [Auto Detect] screen appears.

1 Check to ensure that [Auto Detect] is selected, followed by pressing the [16/ENTER] button

- The “Please wait...” message appears.

Memo :

- The characters of the selected item switches to orange color.

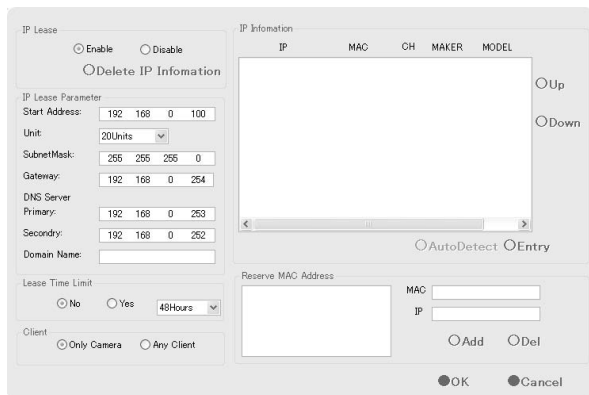

2 Check to ensure that the camera is detected

- After the message disappears, a list of detected cameras is displayed.
- If all the cameras are not detected, press the [Auto Detect] button again. If doing so does not solve the problem, check the connection with the cameras and the IP address of the cameras.

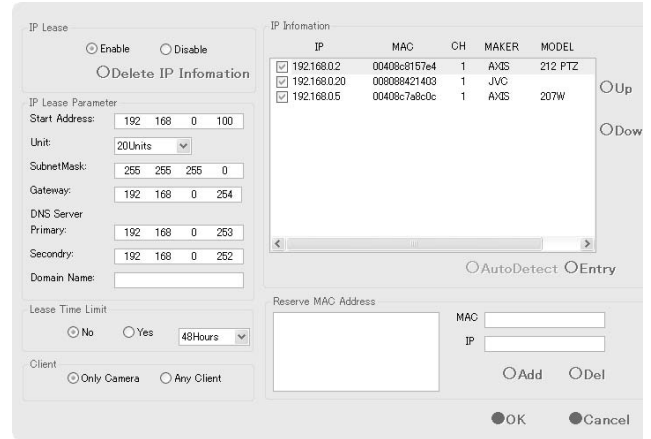

Memo :

- Devices other than the cameras may appear in the list. Uncheck the boxes of these devices.

3 Swap the order of detected cameras

- Select SORT button using [SKIP] button and press [16/ENTER] button. The order of detected cameras can be sorted.
- The different types of sort buttons include the [IP], [MAC], [CH], [MAKER], and [MODEL] sort buttons.
- Select list using [SKIP] button to select [2/D], [10/0/E]. After selecting camera, press [SKIP] button to select [Up], [Down]. When [16/ENTER] is pressed, the order of cameras will be swapped.
- Deselect the check box of any camera that you are not using.

Memo :

- The camera in the upper position of list order has the first priority. Camera number will be registered in the list order.

4 Use the [SKIP] button to select [Entry], followed by pressing the [16/ENTER] button

- The camera that is automatically detected is registered in the system.

Preparation

During Initial Startup (continued)

5 Use the [SKIP] button to select [OK], followed by pressing the [16/ENTER] button

- The [Configure Device] screen appears.



6 Enter the password for the network camera

- Press the [KEY] button to display the software keyboard.
- Use the keypad to move the mouse cursor over the software keyboard.
- Pressing the [16/ENTER] button inputs the characters on the keyboard into the password field.

7 After password entry is complete, press [KEY] again the close the software keyboard

8 Use the [SKIP] button to select [OK], followed by pressing [16/ENTER]

9 Repeat the steps from 5 to 7 for every detected camera

- The [Camera Record Setting] screen appears.

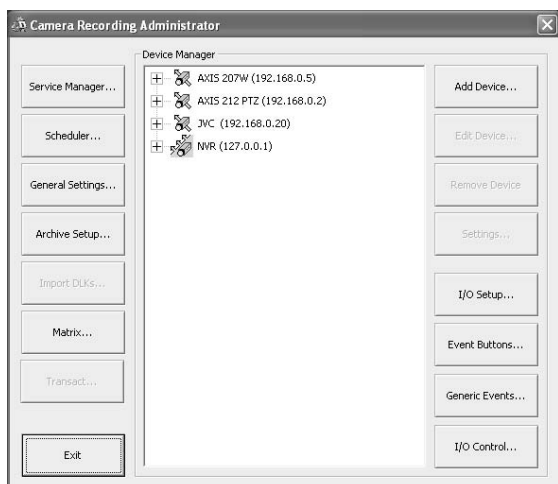

10 Set the display rate of each camera such that the total display rate of all cameras does not exceed 80 ips (VR-N1600U/E) or 160 ips (VR-N1600U/E(A)).

- The default display rate is set at 8 ips. The maximum display performance of 80 ips will be exceeded if 11 or more cameras are detected. In this case, you will need to adjust the display rate of each camera using the following steps. (VR-N1600U/E)

Note :

- The recording rate may drop if the total display rate of all cameras exceeds 80 ips (VR-N1600U/E) or 160 ips (VR-N1600U/E(A)).

When playing back the recorded images of VR-N1600U/E(A), set the total display rate to 80 ips or below to display the playback from the main unit and distribution for 13 channels or more simultaneously.

- 1 Press the [SKIP] to select the Device Manager
 - The device at the top of the list is selected.

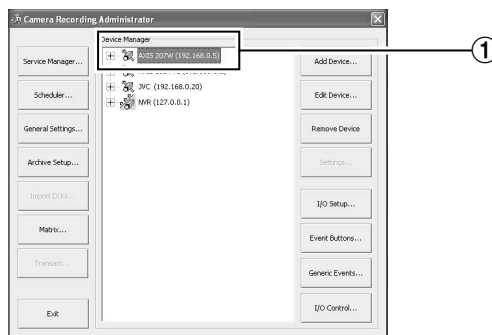

- 2 Use the [2/↑] and [10/0/↓] buttons to select a device

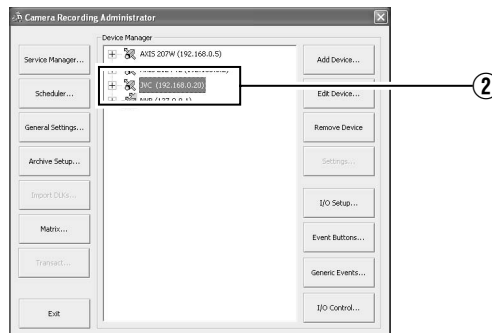

③ Use the [7/➡] button to display the camera

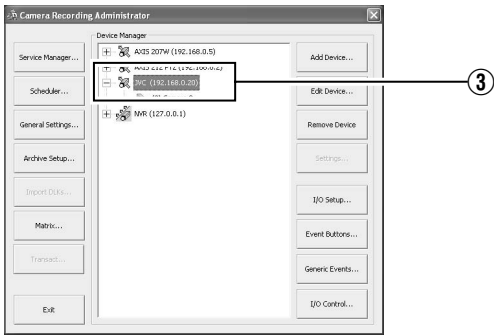

④ Use the [10/0/↓] button to select a camera

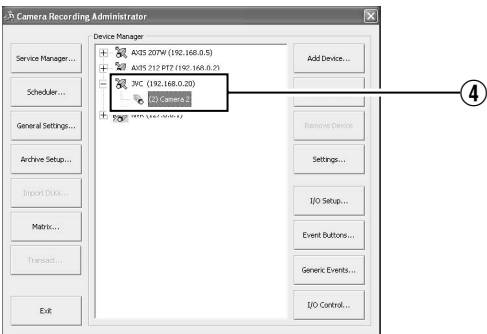

⑤ Use the [SKIP] button to select [Settings...], followed by pressing the [16/ENTER] button

- The [Camera Settings] screen appears.

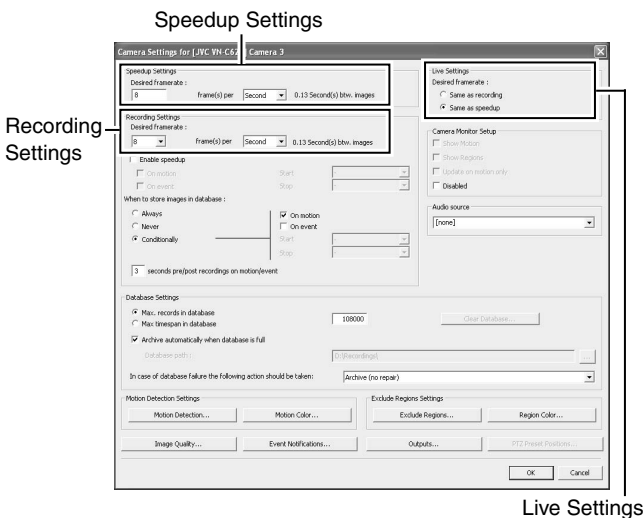

Live Settings

⑥ Setting the Live Image Display Rate

- Select “Same as recording” or “Same as speedup” as the live image display rate in [Live Settings].
- When “Same as speedup” is selected, the [Frame Rate] specified in [Speedup Settings] is used as the live image display rate.
- When “Same as recording” is selected, the [Frame Rate] specified in [Recording Settings] is used as the live image display rate.

Memo :

- Use [SKIP] to move between the items.
- Use the [2/↑] and [10/0/↓] buttons to select the item to configure.
- To enter numeric characters, press the [SELECT] button to turn on the light of the [SELECT] indicator. Upon entering the numeric characters, press the [PTZ/PRESET] button to turn on the light of the [PTZ/PRESET] indicator.

⑦ Use the [SKIP] button to select [OK], followed by pressing the [16/ENTER] button

11 Repeat the procedures 9 for each camera

12 Use the [SKIP] button to select [Close], followed by pressing the [16/ENTER] button

- Setting is complete and the [Live] screen appears.
- The [REC CONTROL] indicator lights up and recording starts in the recording control mode.



[Live] Screen

Basic Operation

Viewing Live Images via Front Panel Control

This section describes the procedures for viewing live images by using the front panel of VR-N1600U/E.



[Live] Screen

Displaying the [Live] Screen

1 Press the [LIVE/BROWSE] button when the wallpaper *1 or main menu *2 screen is displayed.

- Press the [LIVE/BROWSE] button when the [Browse] screen is displayed.
- Press the button to toggle between the [Live] and [Browse] screens.

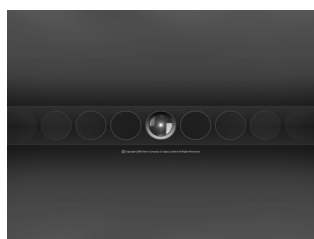

*1 Wallpaper Screen



*2 Main Menu Screen

Note :

- Do not switch the view frequently within a short time interval.
- When live images do not appear on VN-C625/VN-C655, set the password on the camera unit as well as VR-N1600U/E again. For details on the setting procedures, refer to the [INSTRUCRTIONS] of the camera in use and procedures for setting the root password on the [Edit device settings] screen in this manual.
- The audio setting is set to "No Audio Sources" when you return from the setting screen to [Live]. Select the audio parameters again.

Select a Camera

Select the camera image that you want to view as follows.

1 Press the [SELECT] button

- The [SELECT] indicator lights up.

2 Enter the camera number using the [1] to [16] keypad

- When you have selected a camera, the blue bar at the top of each live image changes to a lighter blue tone.
- Each bar comes with a tri-color square indicator, which indicates the following features, as well as characters that indicate the operating status of the camera.



[Live] Screen

Select a View

For details on the view settings, refer to [INSTRUCRTIONS].

1 Press the [PTZ/PRESET] button to switch the [PTZ/PRESET] indicator to the blinking mode

- Press the [PTZ/PRESET] button to switch the [PTZ/PRESET] indicator between the lit and blinking modes.

2 Press the [15/ZOOM IN] and [14/ZOOM OUT] buttons to select a view

Memo : _____

① **Event indicator (Left: yellow)**

Lights up when events specified in the [Camera Record Setting] occur. The indicator appears black if event indication has not been specified for the camera in question, or if no specified event has occurred.

② **Motion indicator (Center: red)**

Lights up when motion is detected.

③ **Online indicator (Right: green)**

Blinks every time an image is received from the camera.

④ **Operating status of the camera (Appears to the left of the indicator)**

Display	Status
Live (Green)	When live images are displayed without being recorded
Recording (Red)	When recording is in progress
Stop (Yellow)	When images are not acquired from the camera, or when the camera is in the offline mode

- You can press the [ALARM CLEAR] button to hide the event indicator and motion indicator.
- The image bar displays the name of the camera as well as the name of the device to which the camera is connected.
- Pressing a number that corresponds to the selected camera enlarges the display. To restore display to the normal size, press the number of the camera with enlarged display.

Operating the Camera

PTZ stands for pan, tilt and zoom.

If the camera supports the PTZ functions, you can use the keypad, and the [16/ENTER] and [13/CANCEL] buttons to move the camera up/down (tilt), left/right (pan), or enlarge/reduce the image (zoom).

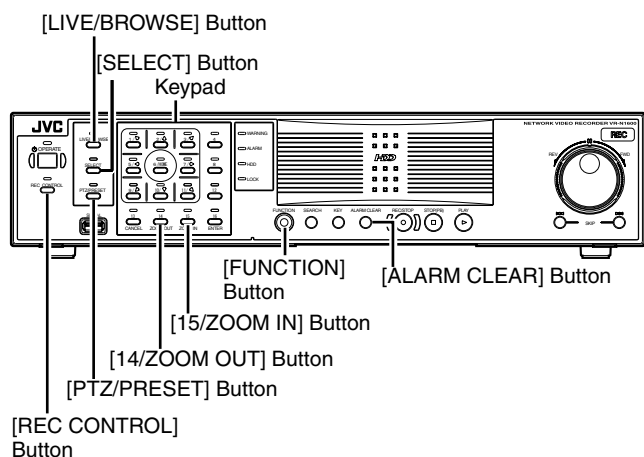

■ Pan/Tilt

1 Press the [PTZ/PRESET] button to switch the keypad to the PTZ mode

- The [PTZ/PRESET] indicator lights up.
- Press the button to switch between the “PTZ Mode” (indicator lights up) and “Preset Mode” (indicator blinking).

2 Press the 1 to 9 keypad

- Pans/Tilts in the direction indicated by the arrow on the keys.
- Press the [6/HOME] key to move to the home position.

■ Zoom In/Zoom Out

1 Press the [PTZ/PRESET] button to switch the keypad to the PTZ mode

- The [PTZ/PRESET] indicator lights up.
- Press the button to switch between the “PTZ Mode” (indicator lights up) and “Preset Mode” (indicator blinking).

2 Press the [15/ZOOM IN] or [14/ZOOM OUT] button

■ Using Preset Positions

1 Press the [PTZ/PRESET] button to switch the keypad to the Preset mode

- The [PTZ/PRESET] indicator starts blinking.
- Press the button to switch between the “PTZ Mode” (indicator lights up) and “Preset Mode” (indicator blinking).

2 Enter the preset number using the [1] to [10/0] keypad

- The camera moves to the preset position.

Memo : _____

- You can specify numbers from 10 to 19 by pressing [10/0] followed by a number from [10/0] to [9].

Note : _____

- You need to specify the preset positions in advance in order to use the preset feature.

Playing Back Recorded Images via Front Panel Control

This section describes the procedures for playing back recorded images using the front panel of VR-N1600U/E.

Displaying the [Browse] Screen

1 Press the [LIVE/BROWSE] button when the wallpaper or main menu screen is displayed

- The NVR Viewer starts up and the [Live] screen appears.

2 When the [Live] screen appears, press the [LIVE/BROWSE] button again

- Press the button to toggle between the [Live] and [Browse] screens.



[Live] Screen

Select a View

For details on the view settings, refer to [INSTRUCRTIONS].

1 Press the [PTZ/PRESET] button until the [PTZ/PRESET] indicator blinks.

- The [PTZ/PRESET] indicator switches between lit and blinking each time the [PTZ/PRESET] button is pressed.

2 Press the [15/ZOOM IN] or [14/ZOOM OUT] button to select a view

Note :

- Do not switch the view frequently within a short time interval.
- When live images do not appear on VN-C625/VN-C655, set the password on the camera unit as well as VR-N1600U/E again. For details on the setting procedures, refer to the [INSTRUCRTIONS] of the camera in use and procedures for setting the root password on the [Edit device settings] screen in this manual .
- The setting in the [Audio] section is set to “No Audio Sources” when you return from the setting screen to [Browse]. Select the audio parameters again.

Searching Recorded Image Using a Specific Date/Time

You can search for and play back images by specifying a date and time using the [SEARCH] button on the front panel.

1 Press the [SEARCH] button on the [Browse] screen

- The date and time input screen appears.

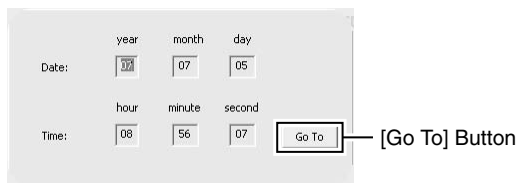

2 Use the keypad to enter the search date and time

- Use the [SKIP] button (S or T) to select an item and input accordingly.

3 Press the [16/ENTER] button

- The view in the image display screen on the right jumps to the selected date and time.

Memo :

- You can also jump to the selected date/time by clicking the [Go To] button.
- When you are using the software keyboard, click the [Go To] button.

Playing, Skipping and Stopping Recorded Images

Control using the [PLAY], [SKIP], and [Stop] buttons.

■ Control using the [PLAY], [SKIP], and [PLAY] buttons on the front panel

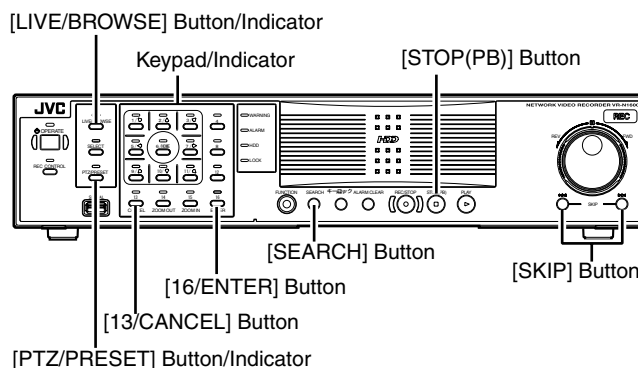

● Playing Back

1 Press the [PLAY] button

- Playback starts from the date/time indicated in [Master Time] of [Time Navigation].
- Images are played back according to the angle of the shuttle dial (x1/20, x1/5, x1, x2, x5, x10, x20).

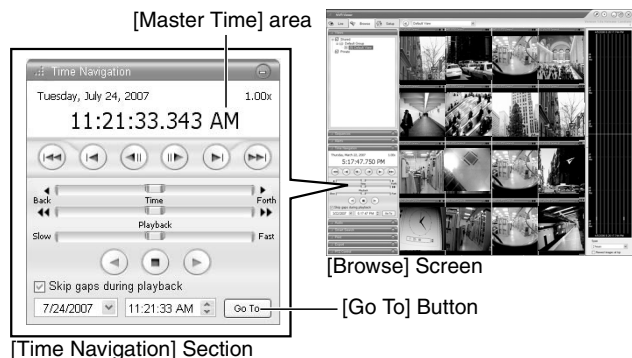

● Skipping

1 Press the [SKIP] button

- The [SKIP] buttons have the following functions.

S	Moves to the first image in the previous sequence. Moves to the oldest image in the database of the selected camera when the button is pressed and held down..
T	Moves to the first image in the next sequence. Moves to the first image in the next sequence. When pressed and held down, moves to the latest image in the database for the selected camera.

Memo :

- "Sequence" indicates a certain block of images that are recorded during motion detection.
- Recorded images are stored in the database.

Note :

- The [SKIP] buttons are only enabled when a camera has been selected.
- During simultaneous recording and playback, an "After Database End" message may appear as playback catches up with recording during playback near the current time.
- When recording is set to be triggered by motion/event, VR-N1600U/E will not start recording unless a motion/event occurs. During playback near the current time, however, the image that is not recorded will also be played.

● Stopping

1 Press the [STOP(PB)] button

- Playback stops.

● Enlarging the Display

- Pressing a number that corresponds to the selected camera enlarges the display.
- To restore display to the normal size, press the number of the camera with enlarged display.

Adjusting the Playback Speed (Jog/Shuttle Playback)

You can adjust the playback speed by turning the jog dial/shuttle dial on the front panel.

■ Shuttle Playback

- Rotate the shuttle dial during playback or when playback is paused to start fast forward, fast reverse or slow playback.

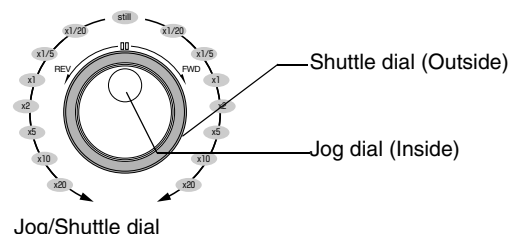

Memo :

- The playback speed that is indicated during fast forward or fast reverse playback by rotating the shuttle dial is an approximate value. The speed may differ depending on the conditions, such as the playback mode (multi-view, single view) and the recording mode (motion detection, recorded frame rate).

■ Jog Playback

- Rotate the jog dial to play back frame by frame.
- Rotate the dial clockwise to play back a single frame in the forward direction, and rotate the dial counterclockwise to play back a single frame in the reverse direction.
- Release the dial to pause the playback. However, when frames are played back successively in the forward or reverse direction, playback may continue momentarily after the jog dial is released.

Note :

- The jog dial is only enabled when a camera has been selected.
- When the playback speed is adjusted or when playing back at high speed during recording, the frame rate of the recording may decrease. Check the performance meter while adjusting the playback speed to ensure that the display does not turn red.

Troubleshooting

Symptom	Action
Power cannot be turned on.	Check to ensure that the power cable has been plugged in correctly. Check to ensure that the power switch on the rear panel is switched on.
Camera is not automatically detected.	Follow instructions in the camera's [Instruction Manual] to check the IP address settings. When the IP Lease feature is in use, turn off and on the power of the camera when VR-N1600U/E is started up.
Unable to control using [REC] and [PLAY].	Check to ensure that the operation lock is not turned on.
Images are not recorded in the recording control mode.	Check the [Camera Recording Settings]. Check to ensure that the scheduler is set to online. Check to ensure that the camera is in the recording control mode.
Unable to play back audio sound.	Check to ensure that the audio item of the camera device is set to "Enabled" in the [Camera Record Setting] menu. Check to ensure that an audio source is selected in [Audio].
Operation of the unit is disabled.	Press and hold the [FUNCTION] button on the front panel, and press the [OPERATE] button for 7 seconds or longer to shut down the power forcibly. When the power is forcibly shut down, recorded images that are not archived may not be properly played back.
The following message appears after the power is turned on. "COMS Settings Wrong CMOS Date/ Time Not Press F1 to Run SETUP Press F2 to load default values and continue"	The built-in backup battery is low. Consult your nearest JVC dealer.

■ Actions when Warning Indicator Lights Up

Error Message	Action to Take
Free space of HDD less than *GB (*drive)	If this message is displayed for the D drive, try to recover using HDD Utility. If the above does not solve the problem, consult your nearest JVC dealer.
WARNING:HDD (Disk)	The HDD seems is no longer serviceable. Replacement is recommended. Consult your nearest JVC dealer.
HDD was removed	Check to ensure that the power of the external HDD is switched on. Check to ensure that the connecting cable is properly inserted. If no abnormality is found above, consult your nearest JVC dealer.
WARNING:HDD (Raid)	This is a hard disk (when RAID is enabled) warning. Consult your nearest JVC dealer.
WARNING:HDD(XXX:) Disconnect	The NAS drive is disconnected. Check the operation of NAS. Check the connection with NAS.
FAN STOP	Fan abnormality. Check to ensure that the fan is running. If the fan is not moving, stop using it. Otherwise, it may break down. Consult your nearest JVC dealer.

Specifications

■ General

Allowable Operating Temperature
: 5 °C to 40 °C

Allowable Storage Temperature
: -20 °C to 60 °C

Allowable Operating Humidity
: 30 % to 80 %

Power Supply

VR-N1600U : AC 120 V, 50 Hz/60 Hz
VR-N1600E : AC 220 V to 240 V, 50 Hz/60 Hz

Consumption Current

VR-N1600U : 1.2 A(max.)
VR-N1600E : 0.8 A(max.)

Mass : Approx. 7.8 kg

■ Interface

Network : RJ-45 × 2

LAN1 : 1000BASE-T/100BASE-TX/10BASE-T

LAN2 : 1000BASE-T/100BASE-TX/10BASE-T

Serial : USB2.0 A-type (or equivalent) × 5

VGA Output : Max. 1600 × 1200

Audio Input : Analog audio RCA × 2 - 8 dBs 50 kΩ (unbalanced)

Audio Output : Analog audio RCA × 1 - 8 dBs 600 Ω (unbalanced)

I/O Terminals : Push terminal
Input × 12
Output × 5
GND × 3

■ Compression Format

Video : JPEG/MPEG-4

Audio : μ-law (64 kbps) A/D 8 bits, Fs = 8 kHz

■ Recording

HDD Capacity : 500 GB × 1

■ Recording/Display/Distribution capacity (for JPEG VGA 24 KB)

When viewing live images on NVR

: Up to 160 ips/80 ips/80 ips (VR-N1600U/E)

: Up to 160 ips/160 ips/160 ips (VR-N1600U/E(A))

When not viewing live images on NVR

: Up to 240 ips/0 ips/80 ips (VR-N1600U/E)

: Up to 240 ips/0 ips/160 ips (VR-N1600U/E(A))
(When NVR Viewer is not started up)

When using NAS

When viewing live images on NVR

: Up to 80 ips/80 ips/80 ips (VR-N1600U/E)

: Up to 80 ips/160 ips/160 ips (VR-N1600U/E(A))

When not viewing live images on NVR

: Up to 80 ips/0 ips/80 ips (VR-N1600U/E)

: Up to 80 ips/0 ips/160 ips (VR-N1600U/E(A))

■ Attachments/Accessories

VR-N1600U

Start-up Guide 1

CD-ROM..... 1

Power Cord (2 m) 1

Rack Mount Bracket 2

Warranty Card 1

Service Information Card..... 1

Screw (M4×10 mm)..... 4

Screw (M5×11 mm)..... 4

VR-N1600E

Start-up Guide 1

CD-ROM..... 1

Power Cord (2 m) 2

Rack Mount Bracket 2

Screw (M4×10 mm)..... 4

Screw (M5×11 mm)..... 4

■ Dimensional Outline Drawing (Unit: mm)

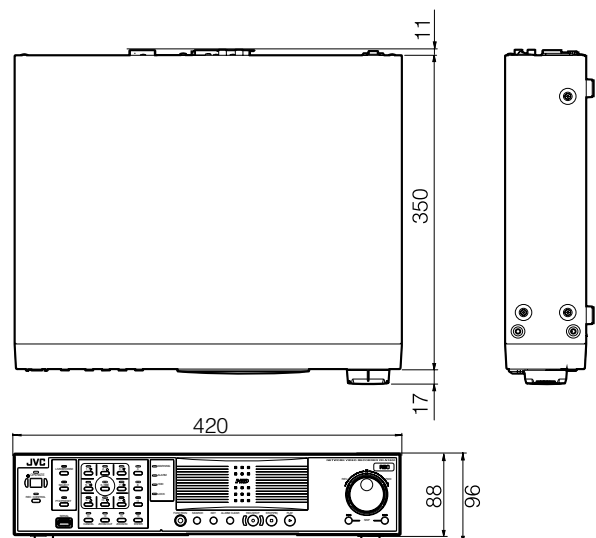

* The specifications and appearance of this unit may be modified for improvement without prior notice.





**NETWORK VIDEO RECORDER
VR-N1600U/VR-N1600E**

JVC